

# Google SketchUp Math Project: Grades 6 - 9

*This project works in any version of SketchUp.*

This is a fun project because it involves making 3D shapes in SketchUp, and also in “real life” with folded paper.

---

*If you need some basic information on downloading Google SketchUp, or about its user interface and basic tools, please see our printable “Intro to SketchUp” PDF.*

The PC version is at [www.3dvinci.net/SketchUp\\_Intro\\_PC.pdf](http://www.3dvinci.net/SketchUp_Intro_PC.pdf).

The Mac version is at [www.3dvinci.net/SketchUp\\_Intro\\_MAC.pdf](http://www.3dvinci.net/SketchUp_Intro_MAC.pdf).

---

First, some easy folding, to make a cube and pyramid:

1. This should be done in **Top** view (**Camera / Standard Views / Top**). You will automatically open SketchUp in top view if you choose one of the “plan view” templates at startup.
2. Use the **Rectangle** tool to make a square.

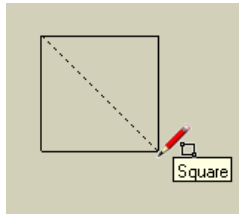

3. Copy the square like this, so that you have six total. This is an unfolded cube (there are actually 10 other ways to arrange the squares as an unfolded cube).

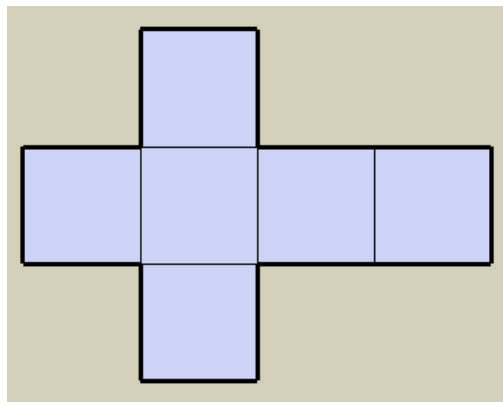

4. For the pyramid, use the **Polygon** tool to make a triangle.

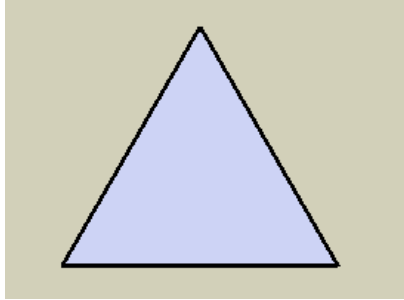

5. You could make copies of the triangle, but an easier way is just to make another triangle inside the first one.

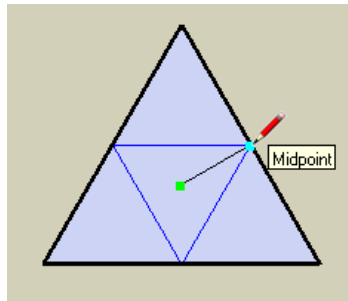

6. Use **File / Print** to print the sets of squares and triangles. (There's an option in the **Print** window to fit everything in one page.) Then cut out the shapes, and fold and tape them into place.

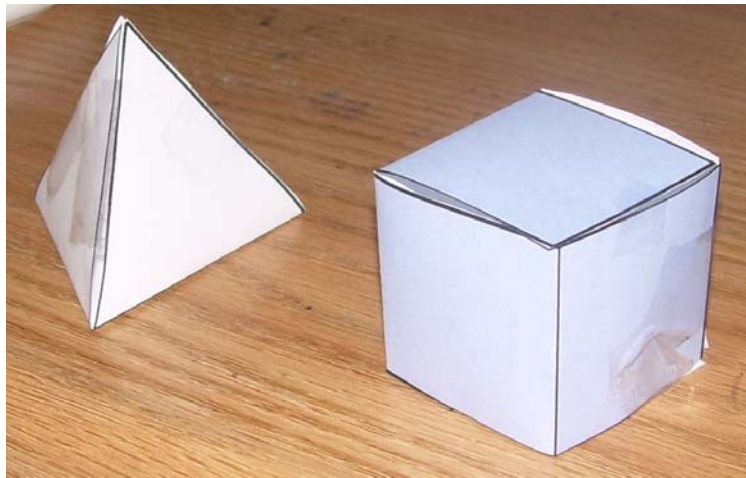

Now let's do the reverse: make a 3D shape in SketchUp and unfold it in SketchUp.

1. Use **Rectangle** and **Push/Pull** to make a box.

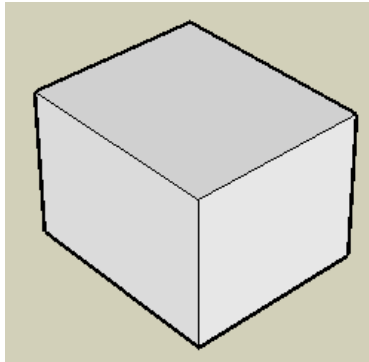

2. A box is boring, so we'll make it more interesting. Use **Scale** on the top face to shrink it. (Press Ctrl / Option while using **Scale** to scale about the center of the face.)

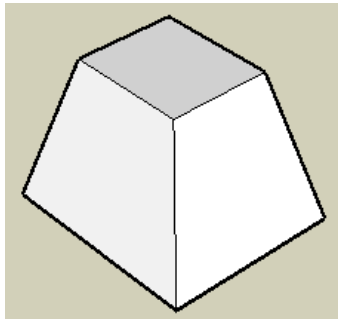

3. You can't unfold the faces like this, because they are all stuck together. To separate them, each face must be a group. Select a face plus its edges (while using **Select**, you can double-click a face for this). Right-click on the face, and choose **Make Group**.

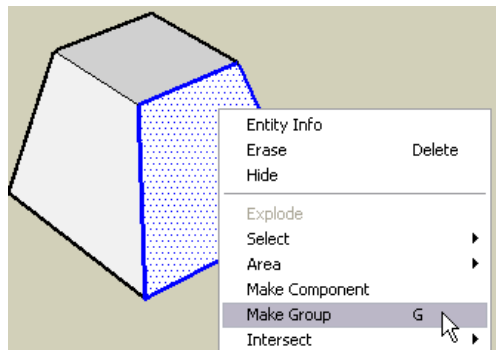

You should now see a bounding box around the face.

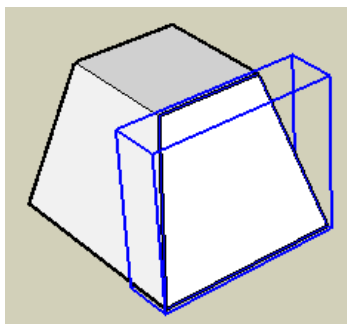

4. Do this for every face on the box. (You don't have to make a group out of the bottom face.)
5. To unfold, **Select** the face you want to unfold, and activate **Rotate**. To set the rotation axis, click on one endpoint and keep the mouse button pressed. Then drag the mouse to another point on the axis and release the mouse button.

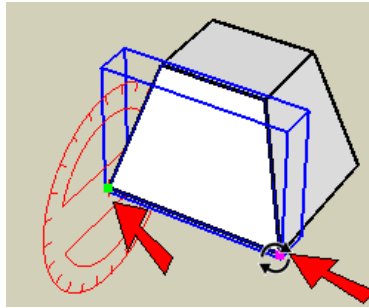

6. Then you can unfold the face so that it's lying flat.

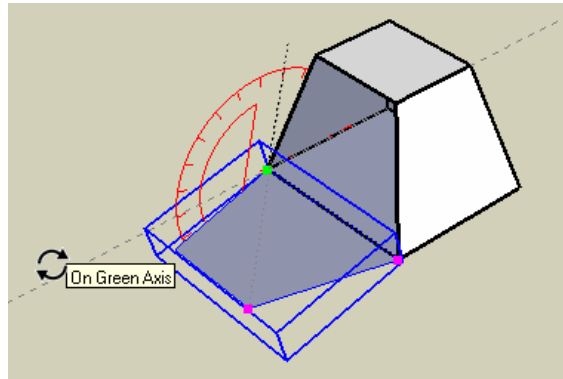

7. Keep unfolding faces one by one. When you get to this stage, you have two connected faces that need to be unfolded together. (If you just unfold the larger vertical face, the top face will be left hovering alone in space.)

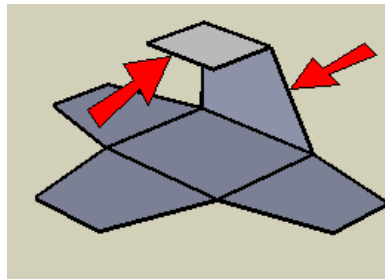

8. So **Select** both of these faces and unfold them. This leaves the small top face still sticking up.

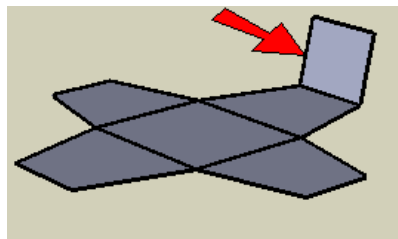

9. Finish up by flattening that last face. Now you can print and fold this to get your box.

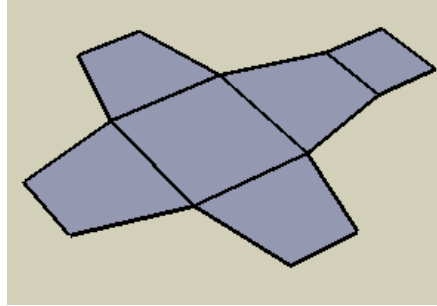

Here are some more interesting examples. For this one, you need to be careful to unfold multiple faces at once, so that no faces are left alone in space.

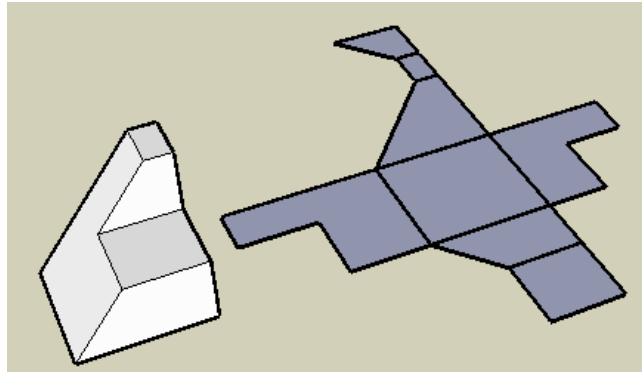

This one is especially tough - a box with a smaller box cut out at one corner.

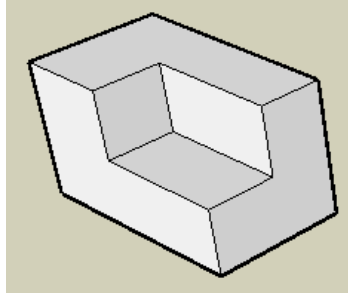

This is how the shape above looks when unfolded. It's tricky - make sure you don't unfold to get any overlapping faces! Also be careful when you print, cut, and fold the one above. Where you have faces of the cutout box, you need to know which edge to cut!

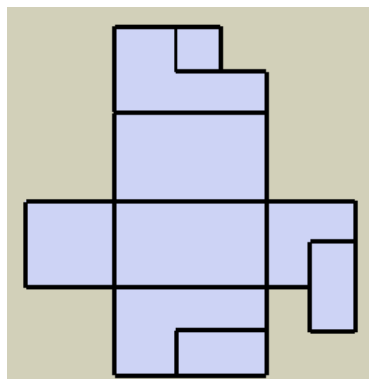

If you like this project, please check out 3DVinci's GeomeTricks Series (<http://www.3dvinci.net/ccp0-catshow/GM.html>). The books shown below are among those that are appropriate for this age group, and teach concepts such as periodic and aperiodic tiling, fractals, and 3D Solids. Click each book graphic for more information.

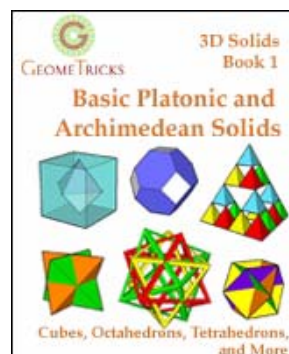
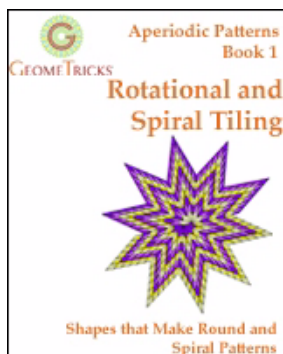
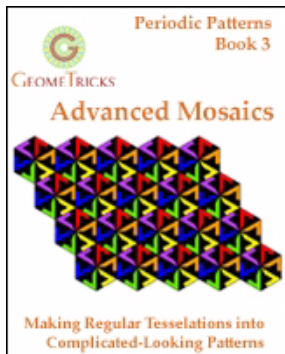

And if you want to receive three ready-to-use projects like these each month, sign up for our SketchUp Projects of the Month subscription (<http://www.3dvinci.net/ccp0-prodshow/POM.html>). Each month, you'll get one project related to geometry, and two projects that teach a 3D design concept.

Also, be sure to check out our free geometry projects at [www.mathforum.org/sketchup/](http://www.mathforum.org/sketchup/)

All of the models in the Teacher Guide can be downloaded from Google's 3D Warehouse: <http://sketchup.google.com/3dwarehouse>.

- Click [this link](#) to see the entire Warehouse collection of models used in the Teacher Guide.
- Click [this link](#) to locate this exact folding model in the Warehouse.

If you're reading this as a printed PDF and can't click on the links, here's how to find the Teacher Guide models:

1. Open the 3D Warehouse.
2. In the **Search** field, type "3dvinci teacher guide" and choose **Collections**. Then press Enter or click the **Search** button.

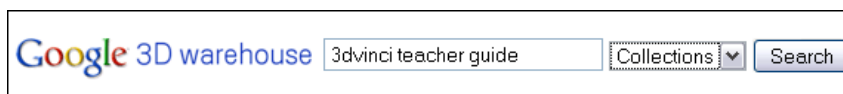

3. Open this link:

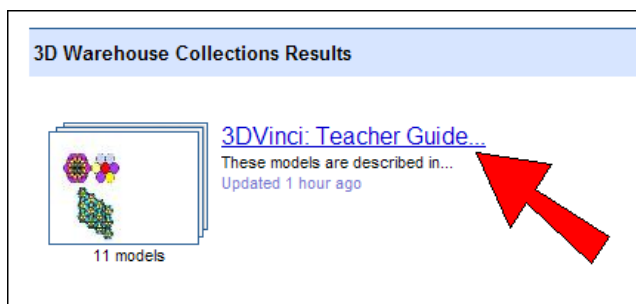

4. In the collection, find the model you want, and open or download it.